

# SPERO 10

## Ce qui est inclus

Vérifiez que les pièces suivantes sont fournies dans l'emballage :

- A. SPERO 10
- B. Guide de Démarrage Rapide
- C. Chargeur Rapide USB-C (non inclus)

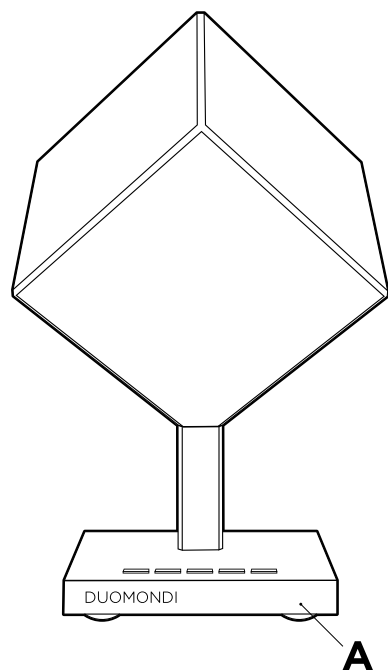

## Commandes des boutons

Niveau de volume  
Indication

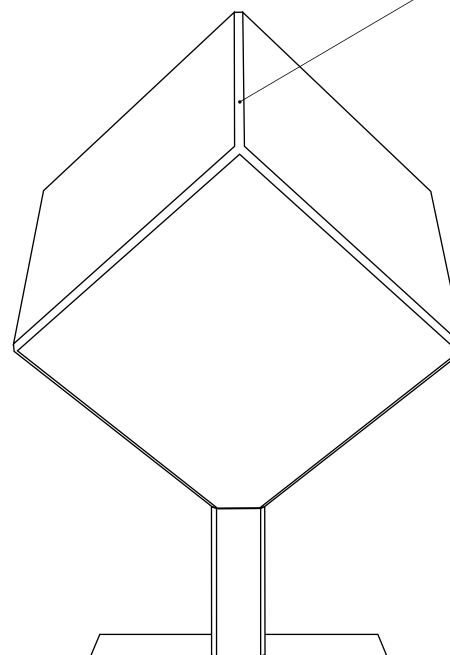

-  Interrupteur D'alimentation
-  Diminution du Volume
-  Bluetooth
-  Augmentation du Volume
-  Contrôle de L'éclairage

## Connexions

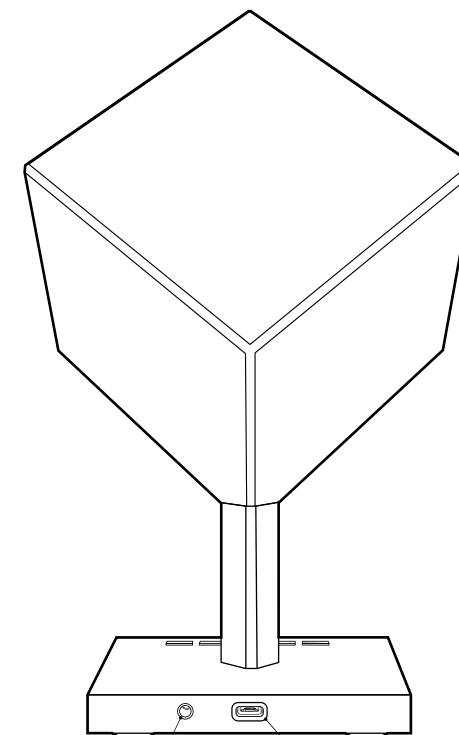

-  3,5 mm Entrée audio
-  USB-C Chargeur

### Connexion de l'alimentation

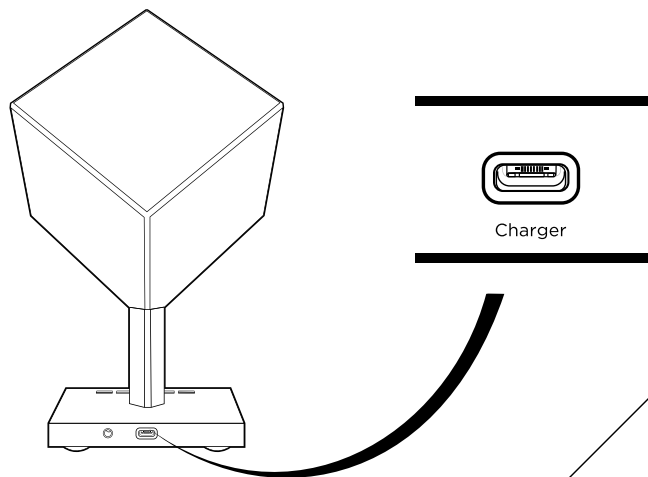

### Contrôle de l'alimentation

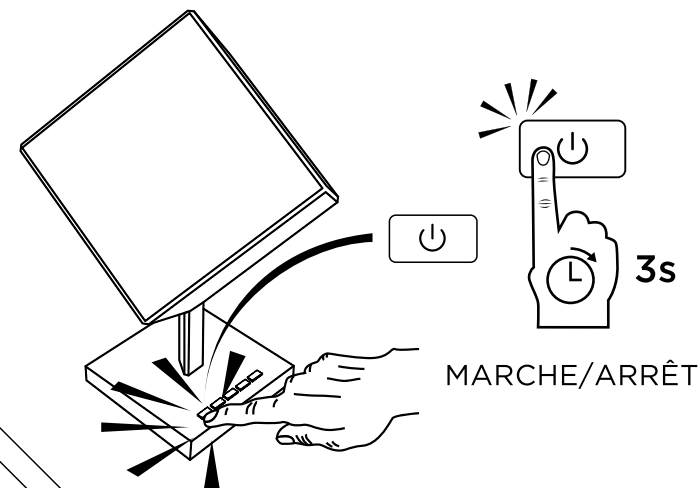

# SPERO 10

### Appairage Bluetooth

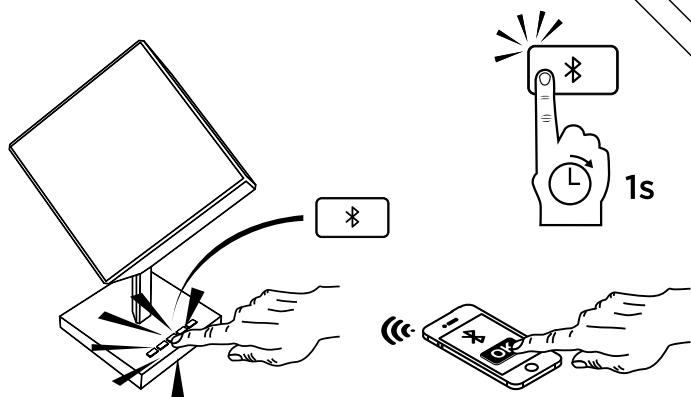

### Affichage du Niveau Audio

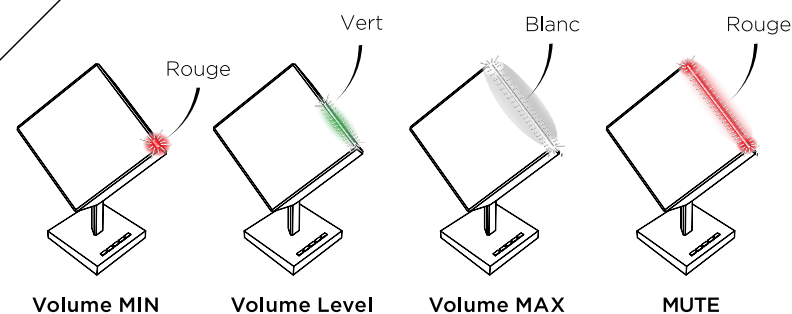

Niveau de la batterie

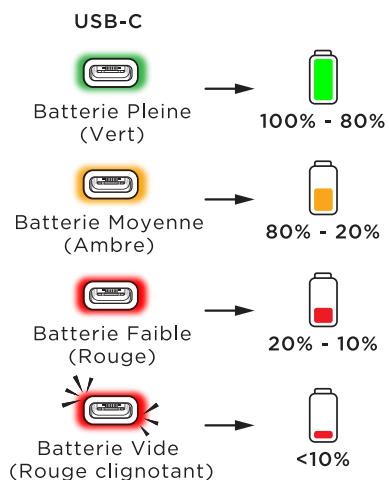

Chargement

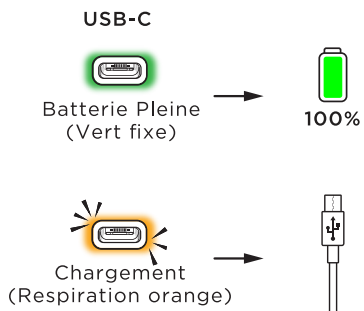

Mode appairage stéréo sans fil

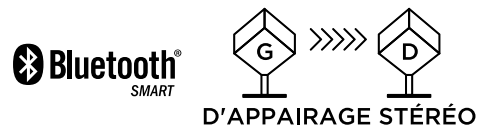

Mode D'appairage Stéréo

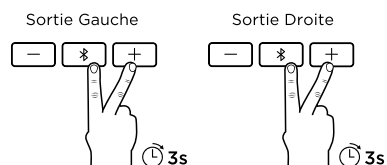

Appairage stéréo réussi

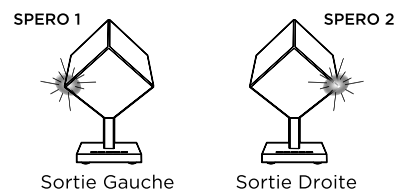

Suppression de l'appairage stéréo

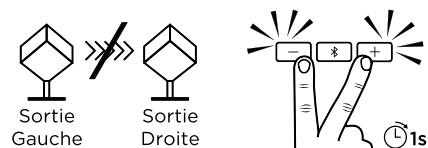

Contrôle Sans Fil

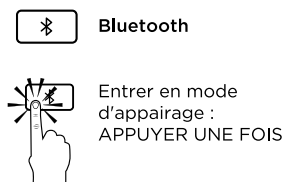

Commandes D'éclairage

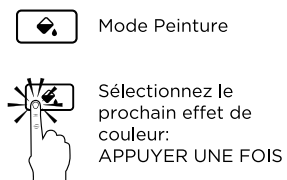

Commandes Audio

